



EC-R3588SPC

| 8-Core AI Industrial Computer

T-CHIP INTELLIGENCE TECHNOLOGY

V1.0



Product features

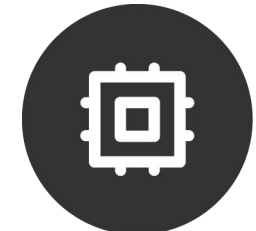

8-Core 64bit processor

8-Core 64bit processor RK3588S
8nm lithography process.up to
2.4GHz

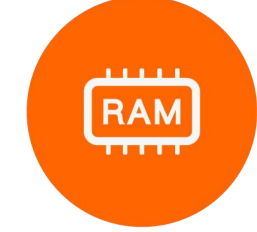

Super-large 32GB RAM

Up to 32GB RAM
Support LPDDR4/LPDDR4x/LPDDR5

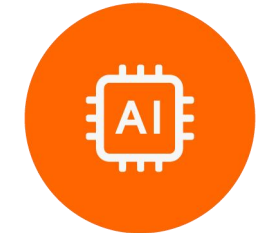

GPU / VPU / NPU

OpenGL ES3.2/2.0, Vulkan1.1
8K@60fps H.265/VP9 Decoding
8K@30fps H.265/H.264 Encoding
6TOPS NPU computing power



Network communication

1*1000Mbps、1*100Mbps Ethernet
2.4G/5G Dual-band WiFi、BT4.2
Expandable 4G LTE



Operating systems

Support Android 12.0、
Ubuntu(desktop & Server)

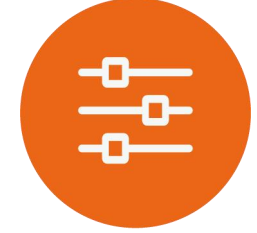

A variety of interfaces

HDMI2.1、USB3.0、USB2.0、USB-C
RS232、RS485、CAN、Relays

Specifications



Specifications	
SOC	RK3588S
CPU	8-64bit (4xCortex-A76+4xCortex-A55) , 8nm lithography process, up to 2.4GHz
GPU	ARM Mali-G610 MP4 GPU, Support OpenGL ES3.2 / OpenCL 2.2 / Vulkan1.1, 450 GFLOPS
NPU	6 TOPS, Support INT4/INT8/INT16 mixed operation,Support framework switching of TensorFlow / MXNet / PyTorch / Caffe
Codecs	Decoding: 8K@60fps H.265/VP9/AVS2、8K@30fps H.264 AVC/MVC、4K@60fps AV1、1080P@60fps MPEG-2/-1/VC-1/VP8 Encoding: 8K@30fps H.265 / H.264
RAM	4GB/8GB/16GB (up to 32GB) 64bit LPDDR4/LPDDR4x/LPDDR5
Storage	16GB/32GB/64GB/128GB eMMC
Storage Expansion	1 * M.2 slot is for 2242 SATA3.0 SSD (default), compatible with 2242 PCIe2.0 NVMe SSD, 1 * TF Card
Ethernet	1 * GE(RJ45) 、 1 * 100Mbps(RJ45)
Wireless	2.4G/5GHz Dual-band WiFi, 802.11 a/b/g/n/ac、 Bluetooth 4.2, Extended to 4G network
Video	1 * HDMI2.1 (8K@60fps or 4K@120fps) 、 1 * DP1.4 (8K@30fps) , Support dual screen output with different displays
Audio	1 * 3.5mm Audio jack (support Mic) 、 1 * HDMI2.1 Audio output 、 1 * DP1.4 Audio output
USB	1 * USB3.0 (Max:1A) 、 1 * USB2.0 (Max:500mA) 、 1 * USB-C (USB3.0 OTG / DP1.4) (Max:2A)
Other Interfaces	RS232 、 RS485、 CAN、 Relays
Power	DC 12V (5.5*2.1mm)
OS	Android 12.0, Ubuntu desktop and Server
Dimension	96.6 mm * 72mm * 64mm
Weight	≈0.45kg
Power Consumption	Idle: ≈0.42W (12V/35mA), Typical: ≈2.25W (12V/190mA), Max: ≈12W (12V/1000mA)
Environment	Operating Temperature: -20°C ~ 60°C, Storage Temperature: -20°C ~ 70°C, Storage Humidity: -40% ~ 70 %

Interface description

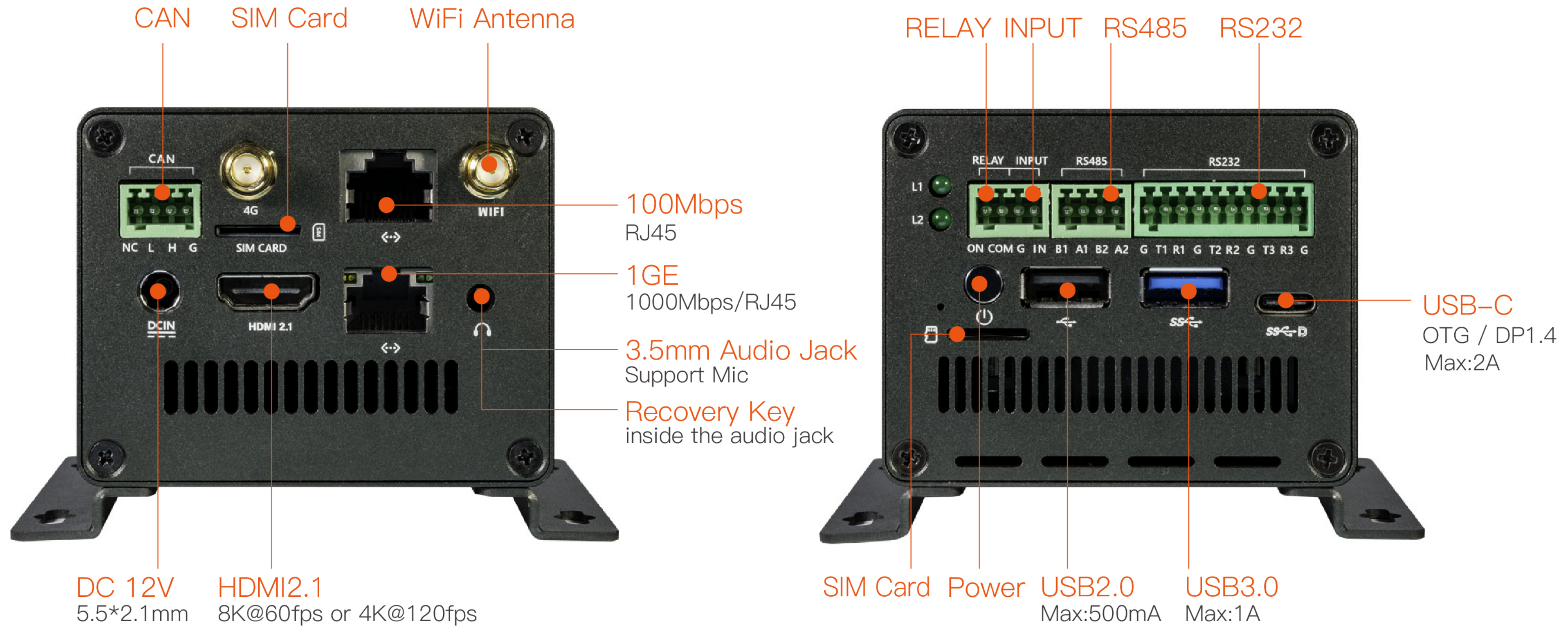

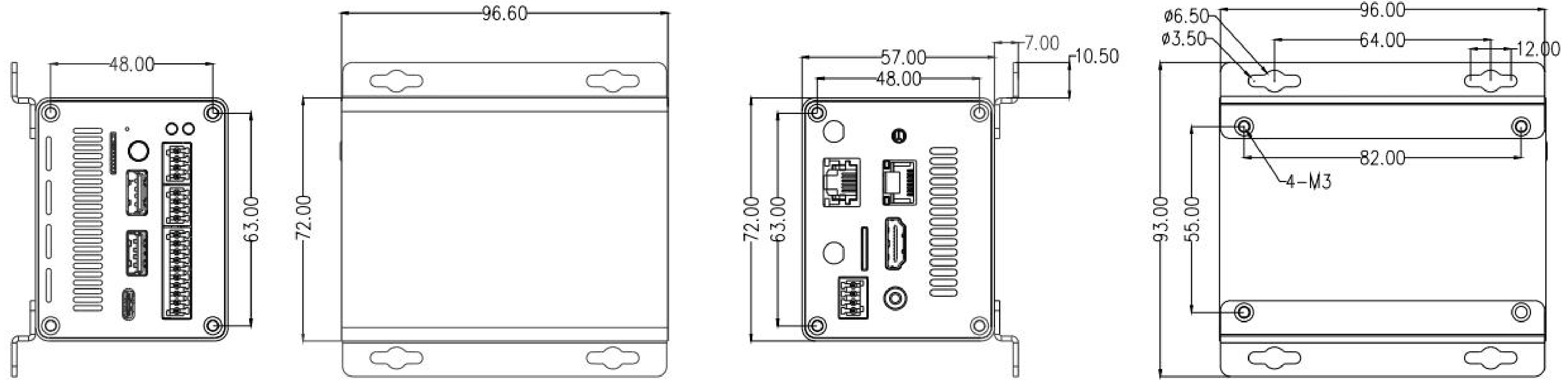

Dimension





T-CHIP INTELLIGENCE TECHNOLOGY

 Contact Us
(+86)18688117175

 E-mail
global@t-firefly.com

 Website
www.t-firefly.com

 Address
Room 2101, Hongyu Building, #57 Zhongshan 4Rd, East District,
Zhongshan, Guangdong, China.